

WINGET

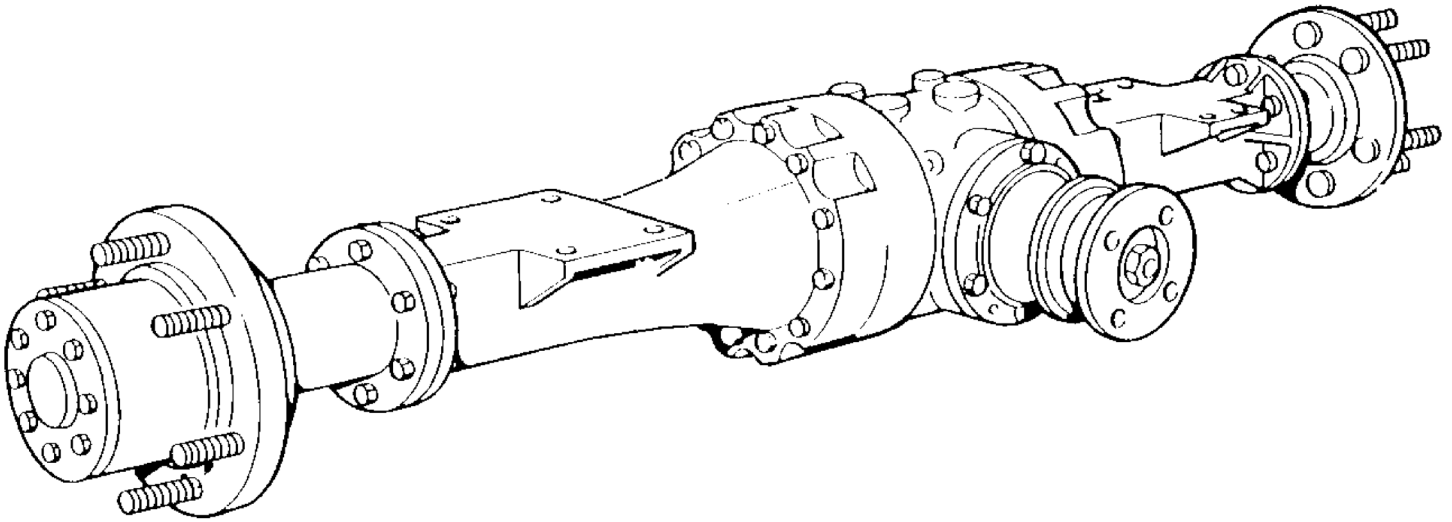

NEWAGE 410 SERIES AXLE SERVICE MANUAL

WINGET LIMITED
PO BOX 41
EDGEFOLD INDUSTRIAL ESTATE
PLODDER LANE
BOLTON
LANCS BL4 OLS
U.K.
Tel:++44(0)1204 854650
Fax:++44(0)1204 854663
E-mail service@winget.co.uk
www.winget.co.uk

CONTENTS

INTRODUCTION

GENERAL DESCRIPTION

IDENTIFICATION

GENERAL SERVICE INFORMATION

EXPLODED VIEW/PARTS LIST

SECTION A PINION CARTRIDGE

SECTION B DIFFERENTIAL ASSEMBLY

SECTION C PLANET CARRIER ASSEMBLY

SECTION D HUB, AXLE STUB AND AXLE ARM ASSEMBLY

SECTION E BRAKES

SECTION F SETTING UP CROWNWHEEL AND PINION

SECTION G SPIRAL BEVEL GEAR TOOTH CONTACTS

Section 1

INTRODUCTION

Introduction

Winget Limited gratefully acknowledge the assistance given by Newage Transmissions Limited in the preparation of this manual, however neither Winget Limited or Newage Transmissions can be held responsible for any errors or omissions.

The procedures described within this manual should enable experienced service personnel to strip, repair and re-build Newage 410 series axles fitted to Winget 4S range site dumpers in a safe and competent manner. The procedures are not intended to be used by personnel who are unfamiliar with the product or mechanically inexperienced.

It is assumed that personnel are aware of the Health and Safety Regulations which should be applied but the following should act as a reminder.

Whenever possible any repairs or service should be carried out in a clean environment. If work must be carried out on site or in the field steps should be taken to ensure that dirt or foreign materials cannot enter the assembly.

Ensure all work tools are in good condition and only use the correct tool for the job in hand.

Always wear safety spectacles when using soft or hard faced hammers, chisels, drifts or when using air tools. Wear safety spectacles when cleaning components or when grinding.

Do not misuse air lines and be aware of the damage compressed air can cause if misused.

Always make sure lifting equipment is in good condition and the Safe Working Load exceeds the weight of the component to be lifted.

Always use suitable supports i.e. axle stands or baulks of timber in conjunction with hydraulic jacks etc. Never rely on hydraulic jacks alone to support a machine.

Be aware of hot surface temperatures and take care when draining hot oils. Always dispose of waste oils in accordance with local and national regulations.

Whenever possible always disconnect the battery or battery isolator when working on the machine to prevent electrical shorts and unauthorised starting.

Refer to the operators handbook for a guide to the correct sequence for assembling components and sub-assemblies.

Oils, fuels, silicone sealer etc can cause skin diseases if allowed to contaminate the skin. Always apply barrier creams, wear suitable protective clothing or when contamination is unavoidable clean the area with soap and water as soon as possible. Do not use thinners or other solvents to clean skin.

Health and Safety is a matter of common sense. If common sense is applied correctly the risk of accidents can be reduced.

Spares for Newage Axles fitted to Winget Equipment can only be obtained from Winget Limited or one of our authorised distributors and not from Newage Transmissions Limited. Always quote your machines serial number and model together with axle serial number and model when ordering spare parts.

410 Series axles are designed to operate under arduous conditions and providing they are regularly and correctly maintained they will provide long trouble free service.

Whilst every effort is made to ensure the contents of this manual are accurate Winget Limited and Newage Transmissions reserve the right to alter specification without prior notification and certain sections of this manual may then no longer apply.

Section 2

GENERAL DESCRIPTION

General Description

The 410 series is a double reduction drive axle with integral long life oil immersed multiplate disc brakes.

Housed within the central housing is the spiral bevel crownwheel and pinion assembly. The crownwheel is mounted on a four pinion differential.

The planetary reduction gears and brake plates are housed within the ends of the axle arms.

The axle half shafts are fully floating and the wheel hubs run on opposed taper roller bearings.

The approximate weight is 220KG (485lb).

Section 3

IDENTIFICATION

Identification

A plate is attached to the centre housing of each axle on which are stamped details of the axle specification (see illustration below) and the axle serial number.

If you require spares, both numbers on the plate should be quoted together with the machine model and serial number.

The model number allocated to each axle describes the basic specification as follows:-

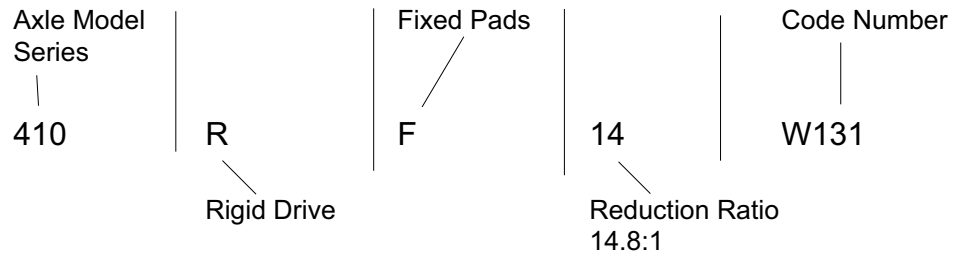

Section 4

GENERAL SERVICE INFORMATION

General Service Information

Routine Maintenance

<u>Check</u>	<u>Interval</u>
For oil leaks around joints and seals	Weekly/50 hours
Wheel nut tightness	Daily/8 hours
Hub bearing adjustment	12 Monthly/1000 hours
Axle arm/centre case bolts	Weekly/50 hours
Halfshaft securing nuts	Weekly/50 hours
Propshaft nuts and bolts	Weekly/50 hours
Brake pipe connections	Weekly/50 hours

Lubricants

The oils used must have the correct additives to be compatible with the mineral oil braking system, therefore, only those lubricants shown below or their direct equivalents must be used.

Mobil Fluid 422
Agricastrol AS Special
Esso Torque Fluid 56 or 62
Gulf Universal Tractor Oil
Total Universal Plant Oil
Total Transmission MP

The oil is added via the combined filler/level plug located in the face of the centre housing on the opposite face from the input flange.

THE OIL CAPACITY IS APPROXIMATELY 6.25 LITRES (11 PINTS)

Greases

The oils seals in the areas listed below should be packed with grease whenever a major overhaul or a repair to one of these areas is carried out.

- 1) Hub Seal - between the V Ring Seal and Hub Oil Seal.
- 2) Pinion Oil Seals

Using the one of the following greases or their equivalents.

Mobil Grease MP
Esso Beacon 2
Total Multis EP2

Brake Fluid

The oil immersed brakes are operated using a mineral hydraulic fluid. On no account must a vegetable based brake fluid be used otherwise all braking system seals will be damaged.

Whenever the brakes are serviced it is essential that the cylinder bores, pistons and seals are cleaned before assembly and lubricated using one of the following mineral oils or their equivalent.

Total Azzola ZS46	Total Azzola ZS22	
Shell Tellus 27	Mobil DTE 24	Esso Nuto H32

Liquid Sealants

On assembly the following mating surfaces should be coated as indicated. Under no circumstances should Silicone RTV Compound be used on the Pinion Housing/Cartridge or the Axle Arm to Case Joints.

Pinion Housing/Cartridge to Maincase	Hermitite
Axle Arm to Main Centre Housing	Hermitite
Stub Axle to Axle Arm (Where applicable)	Hermitite
Halfshaft to Hub Compound	Silicone RTV

Tightening Torques

<u>Description</u>	<u>Kpm</u>	<u>Torque</u> (lbft)
Differential Assembly Nuts & Bolts	7.8	56
Brake Cylinder to Maincase Capscrews	5.8	42
Pinion Cartridge to Maincase Setscrews	5.8	42
Axle Arm to Maincase Bolts	5.8	42
Halfshaft to Hub Nuts	16	115
Stub Axle to Axle Arm Nuts and Bolts	25	180
Hub Assembly Ring Nut	14	100
Wheel Nut 5/8 BSF	25	180
Wheel Nut 18mm	28	200
Brake Pipe Adaptors	2.8	20

NEWAGE TRANSMISSIONS: TORQUE VALUES FOR FASTENERS WITH CLEAN & DRY THREADS

IMPERIAL IN POUNDS-FEET (LBF-FT) PLAIN THREADS												
SIZE	GRADE S			GRADE V			GRADE X					
	NOM.	MAX.	MIN.	NOM.	MAX.	MIN.	NOM.	MAX.	MIN.	NOM.	MAX.	MIN.
1/4	8	10	7	11	13	10	14	16	12			
5/16	17	19	14	23	26	19	28	32	23			
3/8	30	35	26	41	47	35	50	58	43			
7/16	48	55	40	65	75	55	79	91	67			
1/2	73	84	62	100	115	85	121	140	103			
5/8	146	168	124	200	230	170	243	279	206			
3/4	255	294	217	349	402	297	423	487	360			
1"	606	696	515	829	953	704	1004	1155	853			

METRIC IN NEWTON/METRES (Nm) PLAIN THREADS												
SIZE	GRADE 8.8			GRADE 10.9			GRADE 12.9					
	NOM.	MAX.	MIN.	NOM.	MAX.	MIN.	NOM.	MAX.	MIN.	NOM.	MAX.	MIN.
5	6	7	5	8	9	7	10	11	8			
6	10	11	8	14	16	12	17	19	14			
8	24	28	20	33	37	29	40	47	34			
10	48	56	40	67	77	57	80	92	68			
12	83	96	72	115	130	100	140	161	119			
16	206	210	160	280	320	240	347	399	295			
20	401	450	340	560	640	480	677	779	576			
24	694	770	570	920	1040	800	1171	1347	995			

IMPERIAL IN POUNDS-FEET (LBF-FT) COATED THREADS, ZINC & ZINC PASSIVATED												
SIZE	GRADE S			GRADE V			GRADE X					
	NOM.	MAX.	MIN.	NOM.	MAX.	MIN.	NOM.	MAX.	MIN.	NOM.	MAX.	MIN.
1/4	10	12	9	14	16	12	17	20	15			
5/16	21	24	18	28	33	24	35	40	29			
3/8	38	43	32	52	59	44	63	72	53			
7/16	59	68	51	81	94	69	99	113	84			
1/2	91	105	78	125	144	106	152	174	129			
5/8	183	210	156	250	288	213	303	349	258			
3/4	319	367	271	437	502	371	529	609	450			
1"	757	871	643	1036	1191	881	1255	1443	1067			

METRIC IN NEWTON/METRES (Nm) COATED THREADS, ZINC & ZINC PASSIVATED												
SIZE	GRADE 8.8			GRADE 10.9			GRADE 12.9					
	NOM.	MAX.	MIN.	NOM.	MAX.	MIN.	NOM.	MAX.	MIN.	NOM.	MAX.	MIN.
5	7	8	6	10	12	9	12	14	10			
6	12	14	10	17	20	15	21	24	18			
8	30	34	25	42	48	36	51	58	43			
10	59	68	50	84	96	71	100	115	85			
12	104	119	88	146	168	124	175	201	149			
16	257	296	219	362	416	307	434	499	369			
20	502	577	426	706	811	600	847	974	720			
24	868	998	737	1220	1403	1037	1464	1684	1244			

Section A

PINION HOUSING

Servicing the Pinion Cartridge Assembly

Section A

Place a suitable container below the axle drain plug underneath the axle centre housing, remove the plug and drain the oil. Dispose of the oil safely in accordance with local bylaws and national regulations.

Remove the setscrews securing the pinion cartridge to the centre housing and lift off the assembly. The cartridge is located to the centre housing on dowels and will require carefully prising free using a small pry bar or similar suitable tool. Take care not to damage or lose the shims fitted between the cartridge and centre housing.

Prevent the flange from turning and undo and remove the self locking nut and flat washer securing the flange to the pinion. Using a suitable puller or drift remove the flange and gently drift the pinion shaft out through the cartridge. Take care to avoid damaging the gear teeth, splines or threads. Prise the oil seals out of the cartridge, slide the old collapsed spacer off the shaft and discard the spacer.

Note: A new spacer should always be fitted.

Inspect the bearings for wear or damage, check the teeth on both the crownwheel and pinion and make a visual check through the differential of the "wheels". If the front bearing race on the shaft needs replacing use a suitable bearing puller to avoid damaging the pinion shaft. If the outer cones need replacing they can easily be drifted out of each end of the cartridge.

Important: If new pinion bearings are fitted check the crownwheel/pinion backlash. See Section F Crownwheel Pinion Set Up.

To re-assemble the cartridge reverse the above procedure fitting a new collapsible spacer, install the pinion shaft through the innermost bearing cone and fit the rear bearing over the pinion shaft. Carefully fit the new oil seals and pack with one of the recommended greases. Refit the flange, coat the inner surface of the flat washer with silicone sealer and loosely refit the washer and self locking nut.

Prevent the flange from turning and tighten the nut until the spacer begins to collapse and all the end float between the pinion bearing is taken up but without pre-loading the bearings.

Slowly continue to tighten the nut, frequently checking the preload, until a preload of 4.5-6.5Kg (9.9-14.3lbs) for new bearings or 2.2-3.50Kg(4.9-7.7lbs) for used bearings is obtained. The preload is measured by winding a length of string round the flange and measuring the load required to turn the flange with a spring balance. Care should be exercised when tightening the pinion nut otherwise the required preload will quickly be exceeded.

If the old bearings have been reused coat the mating surface of the pinion cartridge and centre housing with the recommended sealant and fit the original shimpack. Refit the cartridge onto the centre case.

If new bearings have been fitted refer to Section F.

Refit the drain plug and tighten. Remove the combined filler/level plug located midway up the rear of the centre housing and refill the axle with oil. Refit and tighten the level plug.

Section B

DIFFERENTIAL ASSEMBLY

Servicing the Crownwheel and Differential Assembly

Section B

Refer to Sections A, D and E and remove the pinion cartridge, axle arm assemblies, sungears and brake plates.

Withdraw the brake pistons and discard the "O" rings.

Remove the cap headed screws and brake pipe adaptors retaining the brake cylinders into the centre casing, mark both the cylinders and casing so that the cylinders can be refitted in their respective ends of the casing on re-assembly.

Stand the maincase on one cylinder end and carefully withdraw the now upper cylinder, if necessary the cylinders can be "jacked" out of the casing by fitting two setscrews into the threaded holes provided in each cylinder.

Lift out the differential assembly and turn the centre casing over, withdraw the remaining brake cylinder. Note which end of the centre casing the crownwheel is located. Locating the crownwheel into the opposite end of the casing from which it was removed will result in the axle rotation being reversed.

Important: Unless the brake cylinders, differential bearings, differential casing halves or maincase are to be replaced do not disturb the adjusting ring nuts located in the centre of the brake cylinders otherwise the differential bearing preload and crownwheel/pinion backlash will need resetting as described in Section F.

Remove the nuts and bolt securing the crownwheel and the two halves of the differential casing together, lift off the crownwheel and separate the two halves of the casing exposing the differential spiders, pinion and wheels.

Examine each component for wear and replace as necessary. Re-assemble taking care that all components are kept clean, align the indent marks on the casing halves and torque the nuts and bolts to:-

7.8Kpm (56lbft)

Clean the mating surfaces of the brake cylinders and main casing and coat the surfaces with one of the recommended sealants. Reassemble one cylinder into its respective end of the casing and stand the casing on that end. Carefully lower the differential assembly into the centre casing and install the second brake cylinder. Secure with the cap head screws and the brakepipe adaptors.

Lubricate the pistons, new seals and cylinders with clean hydraulic oil (not brake fluid) and assemble the pistons into the cylinders.

Refer to Sections A, D and E and re-assemble the axle.

Section C

PLANET CARRIER ASSEMBLY

Servicing the Planet Carrier Assembly

Section C

To gain access to the planet carrier refer to Sections D and E and remove the axle arm, sun gear and brake plates.

Withdraw the brake spacer plate from within the axle arm and lift out the planet carrier assembly.

Check the teeth on the planet gears, sun gears and annulus gears for wear. The planet gears should run freely on the planet pins without excessive radial play.

To dismantle the planet carrier knock the spring dowels into the planet pins and lightly drift the planet pins out of the carrier. Remove the thrust washers, planet gears and needle bearing. The axle shaft thrust washer is retained by a circlip which can be removed to allow inspection of the washer. Inspect all the individual components for wear and replace as necessary. Before re-assembling the planet carrier remove the old spring dowel pins from the planet pins and ensure new spring dowel pins are fitted on assembly.

If necessary the annulus, which is retained by the dowels, can be withdrawn from the axle arm. If the annulus is replaced the dowels should also be replaced. Ensure the annulus is fitted squarely into the axle on re-assembly.

Locate the planet carrier assembly back into the axle arm engaging the teeth on the annulus gear. Refit the brake spacer plates.

Refit the brake disc plates and sun gear as described in Section E.

Refit the axle arm as described in Section D.

Refit the drain plug, remove the combined filler/level plug and top up the axle oil.

Section D

AXLE ARM & HUB ASSEMBLY

Hub, Stub Axle and Axle Arm Assembly

Section D

The Hub, Halfshaft and Stub Axle can be serviced with the Axle in situ on the machine.

The Hub Assembly

Remove the ring of nyloc nuts round the halfshaft securing the shaft to the hub, withdraw the shaft and check the splines for wear or damage. Check the shaft for signs of twist or distortion (A drip tray placed below the hub will catch any oil which runs from the hub).

Straighten the locking tabs on the lockwasher securing the ring nut, undo the ring nut and remove the nut, lockwasher and spacer, pull off the hub taking care not to drop the bearings, remove the V ring seal located on the rear of the hub.

The front and rear bearing and hub oil seal can be drifted out of the hub, the hub oil seals should be replaced regardless of visual condition. If new bearings are to be fitted ensure they are aligned squarely to their bores before tapping home.

The oil seal housing is an interference fit on the stub axle and can be gently tapped off using a soft faced hammer if it requires replacing. When refitting the replacement care must be taken not to damage or distort the housing. Apply "loctite" grade 601 to the mating surfaces of the housing and stub axle before assembly.

To re-assemble the hub reverse the procedure, lubricating the hub oil seal lip, "V" ring seal and bearings before assembly. Fit a new lock washer.

To Adjust the Hub Bearings

Tighten the ring nut to a torque of 14Kpm (100lbft). Fully rotate the hub a few turns in each direction to seat the bearings and re-check the torque (this operation should be repeated until the locknut no longer turns when the torque is rechecked). Slacken the ring nut back a distance equal to 1 tab of the lockwasher and then bend over a tab to secure the ring nut in place.

Coat the mating surfaces of the hub and halfshaft with one of the recommended sealants and refit the halfshaft aligning the splines and studs. It may be necessary to rotate the hub slightly to align the splines on the halfshaft with the planet carrier within the axle. Re-torque the nyloc nuts. Remove the combined filler/level plug and top up the axle oil.

Stub Axle Removal

The stub axle is retained to the axle arm via a ring of nuts and bolts and is sealed using an "O" ring.

To remove the stub axle it will be necessary to remove the halfshaft. Remove the ring of nuts and bolts and lift the stub axle clear of the arm.

Check all parts for damage, replace the "O" ring, coat the mating surfaces with the recommended sealant and refit the stub axle.

Refit the halfshaft as previously described, top up the axle oil.

Axle Arm Removal

It is recommended that the axle is first removed from the dumper before the axle arm is removed.

Drain the oil from the axle as described under section A, remove the halfshaft as described previously.

Support the weight of the axle arm and remove the ring of bolts around the flange of the arm. Place a drip tray below the axle arm and case to catch any oil which may run out. Carefully withdraw the arm away from the centre housing taking care with the brake plates, discs, sun gears etc. which are located between the axle arm and centre casing.

On refitting the arm ensure the mating surfaces of the arm and centre housing are coated with the recommended sealant. Align the arm with the centre casing, engage the sun gear with the differential, ensure the dowels in the arm are aligned and refit the bolts. Tighten the bolts to the correct torque.

Refit the halfshaft and top up the axle oil.

Section E

BRAKES

BRAKES

Section E

Note: the brakes operate on a mineral hydraulic fluid. On no account must a vegetable based brake fluid be used otherwise all braking system seals will be damaged.

To gain access to the brake components it will be necessary to refer to Section D and remove the axle arm assemblies.

Remove the brake friction and fixed plates from the sun gears and withdraw the sun gears from the planet carriers.

Remove the brake spacer plates from within the axle arms and withdraw the brake pistons from the cylinders located in the ends of the centre casing and discard the seals even if visually in good condition. Ensure replacement seals are suitable for use with mineral hydraulic fluids.

Refer to Section B and F if the brake cylinders require replacement.

Examine all parts for wear or damage, under normal operating conditions the brakes should last several years, but should be replaced if blued, distorted or badly scored or the wear exceeds the limits given below.

Blueing of the brake plates indicates that the brakes have been overheating and slipping. Both sets of plates, plain and sintered bronze, should be replaced and the piston seals renewed.

Distortion normally occurs in conjunction with blueing and again indicates that the brakes have been overheating and slipping. Both sets of plates, plain and sintered bronze should be replaced and the piston seals renewed.

Scoring of the plates indicates that there are loose particles or foreign material suspended in the oil. The axle casing should be thoroughly cleaned out and if necessary the source of the particles or material should be investigated. Both sets of plates, plain and sintered bronze should be replaced and the axle refilled with clean oil.

Wear, if the sintered groove of the bronze brake disc is worn down to a depth of .025 inch, 0.6mm or less, then the plates have reached the end of their working life and should be replaced. Care should be taken when examining the plain brake plates for over a long period of operation these can show a greater degree of wear than the sintered bronze disc. Do not assume because the bronze disc is well within the wear limits that all the brake plates are in an acceptable condition. Replacing the plain brake plates may prolong the working life of the brakes and restore their efficiency.

Lubricate all the parts with one of the recommended mineral oils and carefully refit the brake pistons taking care not to nip the "O" rings.

Refit the brake spacer plates into the axle arms and insert the sun gears into the planetary carrier. Slide a friction plate over the planet carrier upto the brake spacer plate followed by a plain fixed plate, locate the fixed plates on the dowels in the axle arms. Slide on the next friction plate aligning the oil feed holes in the friction plates, followed by a fixed plate (A plain fixed plate must be fitted between the last friction disc and brake piston).

Refer to Section D and refit the axle arms.

Refit the drain plug. Remove the combined filler/level plug and top up the oil.

Section F

SETTING PROCEDURE CROWNWHEEL & PINION

Setting Up The Crownwheel And Pinion

Section F

A) When a new Spiral Bevel Pinion is fitted.

Assemble the pinion and bearings into the cartridge and adjust the bearing preload as described on Section A, note the Mounting Distance "MD" stamped on the front face of the old and new bevel pinions.

The shim pack thickness used with the old pinion must be adjusted to suit the new bevel pinion as follows:-

a) If the new MD is less than the old figure decrease the shim pack thickness by the difference.

b) If the new MD is greater than the old figure increase the shim pack thickness by the difference.

Fit the correctly sized shim pack to the face of the pinion cartridge, coat the mating surfaces with one of the recommended sealants and assemble the cartridge onto the main casing.

B) When the old MD is not available or a new Pinion Housing is fitted.

Assemble the pinion and bearings into the cartridge and adjust the bearing preload as described in Section A.

Using a depth gauge or other suitable measuring instrument accurately measure from the front face of the pinion to the mating/joint face on the pinion cartridge flange, this is dimension "X".

Assemble and seal one of the brake cylinders into the main casing, if new differential support bearings are to be fitted, fit the bearing cone and adjusting ring nut. Stand the case on the cylinder and lower in the differential assembly. Seal and install the second brake cylinder, fitting the bearing cone and ring nut. Equally adjust ring nuts until all the end float is removed from the differential bearings.

Using a depth gauge or other suitable measuring instrument accurately measure from the pinion cartridge flange surface to the ground diameter on the differential assembly. This is dimension "Y".

Read both the Pinion Mounting Distance "MD" and the Pinion Head Thickness "HT" stamped on the front face of the pinion and use the following calculations to determine the shim pack thickness required.

$$a) MD - HT - \frac{129.50}{2} = "A"$$

(129.50 equals the differential case ground diameter)

B) Dimension " Y " - Dimension "X" = "B"

C) "A"- "B", the resulting figure is the thickness of the shim pack to be placed between the pinion cartridge and centre casing.

Select a shim pack of the correct thickness and fit to the pinion cartridge, slacken the differential bearing adjusting ring nuts and install the pinion cartridge to the maincase ensuring the crownwheel and pinion are correctly meshed. Retain the pinion cartridge to the main case using two setscrews.

Retighten the adjusting ring nuts to take up the differential bearing end float and lightly preload the bearings, adjust both ring nuts to give the correct backlash between the teeth on the crownwheel and pinion:-

1410 Hardy Spicer 4 Bolt Flange 0.31 - 0.39mm

The backlash is best checked via a dial indicator clock located against a drive flange hole or located against the head of a nut and bolt which is secured in one of the holes within the flange.

Equally tighten both ring nuts by the same amount to give the correct bearing preload (it is important that the backlash is maintained).

The preload is measured by winding a length of string around the pinion flange and measuring the load required to turn the flange with a suitable spring balance.

Differential Bearing Preload	New Bearings	Old Bearings
	7.5-9.9Kg (16.5lbs-21.80lbs)	3.65-5.3Kg (8.00-11.7lbs)

After setting the differential bearing preload recheck the crownwheel/pinion backlash.

Remove the pinion cartridge assembly and brush some "Engineers Blue" onto a few crownwheel teeth and refit the pinion cartridge. Rotate the pinion flange a few complete rotations in both directions and remove the pinion cartridge.

Examine the contact markings on both flanks of the crownwheel teeth and compare the markings to the illustrations in Section G or the original factory markings.

If the marking is different refer to section G "Spiral Bevel Tooth Contact" and make the necessary adjustments.

Coat the mating surfaces of the main casing and pinion cartridge with the recommended sealant and fit the cartridge.

Secure the adjusting ring nuts using the locking devices, coating the threads on screws with loctite. Re-assemble the remainder of the axle as described in Sections C, D and E.

Section G

SPIRAL BEVEL GEAR TOOTH CONTACT

Spiral Bevel Gear Tooth Contact

Section G

The illustration shown below is intended as a reminder to those who are unfamiliar with the terminology applied to Spiral Bevel Gear Teeth

Convex Flank

Concave Flank

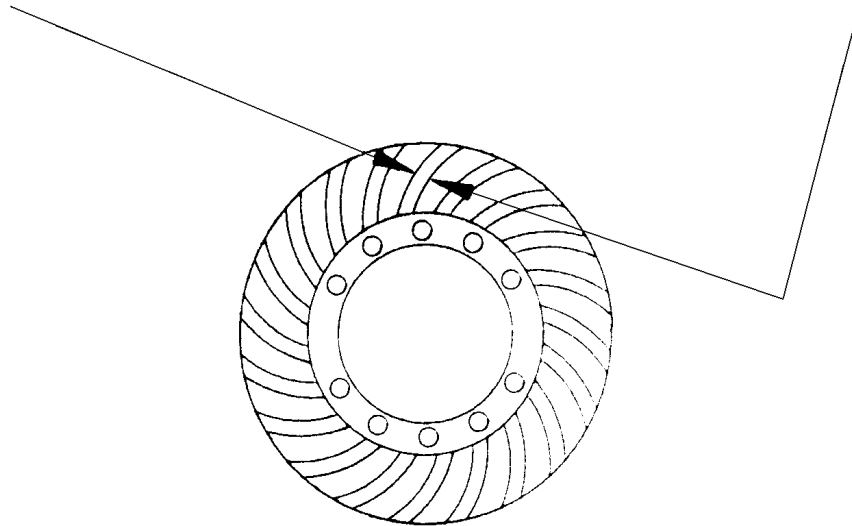

The markings on a crownwheel which is correctly meshed with the pinion should resemble those shown on the illustration below:-

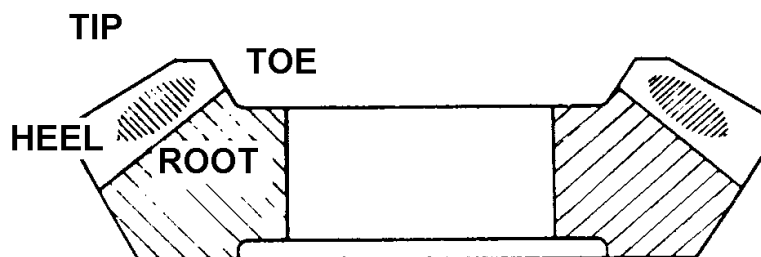

Although the contact point on both flanks of the teeth may vary slightly, generally speaking when correctly setup the markings on both the convex and concave flanks will be in the centre of the tooth form and can still be considered to be correct if, on both flanks, the markings are towards the toe or if crossed slightly e.g. towards the toe on the convex flank and the heel on the concave flank or vice-versa.

If when comparing the contact markings they appear similar to the illustrations below the corrective action indicated is required.

Pinion Too Far Out of Mesh

Convex Flank

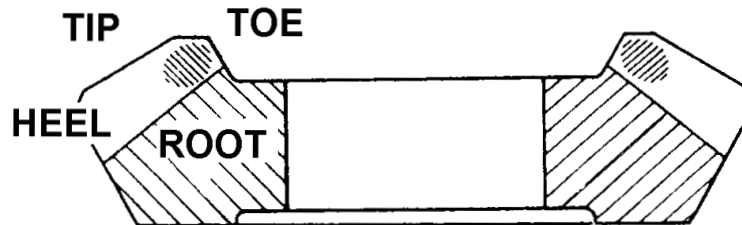

Contact markings closer to toe and tip than factory markings

Concave Flank

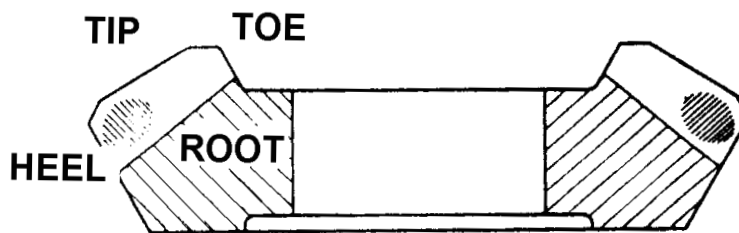

Contact markings closer to heel and tip than factory markings.

Remedy:-

- 175 series Re-check and increase shims behind head of pinion.
- 200 series Re-check and increase shims behind head of pinion.
- 210 series Re-check and increase shims behind head of pinion.
- 220 series Re-check and increase shims behind head of pinion.
- 360 series Re-check and increase shims behind pinion front bearing cone.
- 410 series Re-check and decrease shims between pinion cartridge and axle case.

Pinion Too Far into Mesh

Convex Flank

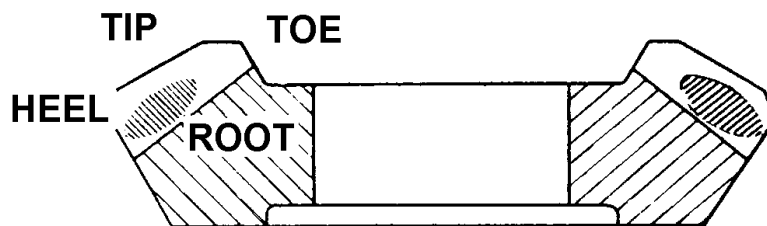

Contact markings closer to heel and root than factory markings

Concave Flank

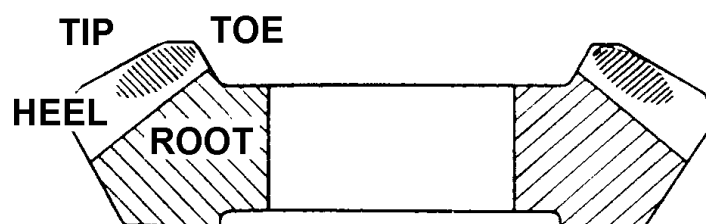

Contact markings closer to toe and root than factory markings.

Remedy:-

175 series Re-check and decrease shims behind head of pinion.

200 series Re-check and decrease shims behind head of pinion.

210 series Re-check and decrease shims behind head of pinion.

220 series Re-check and decrease shims behind head of pinion.

360 series Re-check and decrease shims behind pinion front bearing cone.

410 series Re-check and increase shims between pinion cartridge and axle case.